



Capacitive voltage detecting system

User manual

Document version: 02i05

Update: 2016-02-22



Safety information



When the device is in operation some of its parts may be connected to a hazardous live voltage.



Improper operation of the device or its application to purposes different from the intended use may pose hazards to operators and /or may lead to the equipment damage.



National and local electrical safety regulations must always be followed.



The user shall be held fully responsible for any safety risk and possible failures of the equipment that may arise due to such an improper operation or misuse.



Exploration of damaged device can result in malfunction of protected object and result in threat to life and health.



Reliable and defect-free operation of the device needs appropriate transportation, handling, storage, installation and commissioning as well as correct operation and maintenance.



The device can be installed and operated solely by accordingly trained personnel.

Attention



We reserve the right to modify the device.



Device is an industrial monitoring and control instrument.



Remaining user documentation can be downloaded from energetyka.itr.org.pl

Contents:

1.	Introduction	4
1.1.	Symbols	4
2.	General information	4
2.1.	Destination of the equipment	4
2.2.	Features	5
2.3.	Front panel.....	5
2.4.	Optical signaling	6
3.	Operation manual	6
*)	The condition before starting the DOC mechanism.	6
3.1.	Diagnostic.....	7
3.1.1.	DOC – Device operations check	7
4.	List of referred standards	7
5.	Technical parameters.....	7
5.1.	Input/output circuits.....	7
5.2.	Power supply	8
5.3.	Environmental conditions	8
5.4.	Construction	8
5.5.	Fuse	8
6.	Description of connectors.....	9
7.	Connection diagram	10
8.	Dimension	10
9.	Remarks of manufacturer	11
9.1.	Maintenance, inspections, repairs	11
Also inspections resulting from branch regulations should be undertaken		11
9.2.	Storage and transport	11
9.3.	Place of installation	11
9.4.	Disposal	11
9.5.	Warranty and service	12
10.	Order specification	12
11.	Contact	12

1. Introduction

1.1. Symbols



The electrical warning symbol indicates the presence of hazardous energy circuits or electric shock hazards.



The warning symbol indicates the important information related to the threat to life and health.



The information symbol indicates the clarification of relevant features and parameters of the device.

2. General information

2.1. Destination of the equipment



Device SN 3 is designed for continuous voltage signalization in MV



Fig. 2.1.1 The view of SN 3

SN 3 is provided with **TEST** for local device operations check (DOC).



SN 3 is provided with two relay outputs and two LED diodes signaling the lack of voltage in MV grids. This allows to design local blocking and sound device signaling voltage restoration

The voltage presence is indicated separately for every monitored phase by a displayed symbol ⚡. The device is made to the requirements of the **LRM** system - standard **IEC/PN-EN 61243-5**. Connection with current buses via reactance insulators.



SN 3 is provided with a protection flap to block direct access to the front panel. During normal operation the protection flap should be closed. It shall be opened only for measurements; with measurements complete close the flap again.

2.2. Features

Diagnostic

- Local device operations check mechanism (DOC)

Case

- Small dimensions 125,5 / 55,7 / 50 mm
- Flush mounted

User interface

- 3 signaling diodes: ⚡ **ON** - red diode, voltage presence, ⚡ **OFF** - orange diode, no voltage, ⏻ - supply
- 3 symbols signaling voltage presence on each monitored phase
-  for starting the DOC mechanism

Signalization

Two relay outputs (contact, switch-over):

- voltage on at least one of monitored phases
- no voltage at monitored phases

Voltage presence at each of monitored phases - a lighted signal ⚡ on the LCD display:

- voltage present at each monitored phase - signaled by lighted red diode ⚡ **ON**
no voltage on monitored lines lighted orange diode ⚡ **OFF**

2.3. Front panel

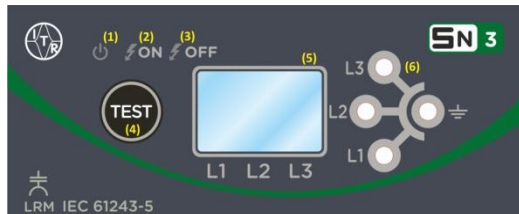





Fig. 2.3.1. Front panel view

On the front panel there are:

- 1) Diode signaling the supply voltage
- 2) Diode signaling the voltage presence
- 3) Diode signaling no voltage present
- 4) Touch key for starting the DOC mechanism
- 5) LCD display
- 6) LRM connector

2.4. Optical signaling

Tab. 2.4.1. Meaning of the predefined diodes:

Symbol/Name	Color	Description
	green	signals feeding of correct supply voltage to the device - continuous light
 ON	red	signaling voltage presence on at least one line
 OFF	orange	signaling no voltage present
	czarny	sygnalizacja obecności napięcia na danej linii







In case of a strong solar radiation on the device front panel it might be necessary to manually dim the LCD display in order to make the signalization better readable..

3. Operation manual

SN 3 is designed for continuous voltage signalization in MV grids. It checks three phase voltages and signals the presence of each of them. It is provided with two binary dry contact outputs (switch-over).

The binary output DO_1 serves for signaling the lack of voltage on monitored lines.

The binary output DO_2 serves for signaling the presence of voltage on monitored lines.

On the front plate there are three diodes: signaling operation of the device , no voltage on monitored lines - orange diode  OFF and voltage on at least one of monitored lines - red diode  ON. On the LCD display a lighted symbol  means voltage presence on each monitored phase (this signal needs no supply).



















Signaling presence or lack of voltage at binary outputs and LED diodes requires voltage supply connected to the device.



If after pressing **TEST** the optical signaling is not excited it means the device is damaged

Tab. 3.1. Operation signaling

LCD signaling			LED signaling		Binary output		Phase voltage		
L1	L2	L3	lack of voltage (OFF diode)	voltage presence (ON diode)	lack of voltage DO_1	voltage presence DO_2	L1	L2	L3
					•				
						•	•		
						•		•	
						•			•
						•	•	•	
						•	•	•	•
TEST			*)	*)	*)	*)	DOC mechanism started		
									

*) The condition before starting the DOC mechanism.

3.1. Diagnostic

3.1.1. DOC – Device operations check



Pressing the  causes the DOC - device operation mechanism to start. This operation consists in a short excitation of the LCD display. This allows to check the device operation during normal operation in MV grid regardless of the voltage presence on distribution busbars.



If after pressing **TEST** the optical signaling is not excited it means the device is damaged.

4. List of referred standards

The device described in this manual has been designed and is manufactured for industrial applications.

The engineering and manufacturing processes assume compliance with relevant standards. Adherence to these standards during installation, commissioning and operation of the device by the user is the essential precondition to achieve the desired performance and safety levels.

The device meets essential requirements specified in the applicable EU Directives:

- Electromagnetic compatibility (EMC) 2004/108/EC
- Low-voltage electrical equipment (LVD) 2006/95/EC

Tab. 4.1 Harmonized standards

Nr. normy	Tytuł normy
PN-EN 61000-6-2:2008	Electromagnetic compatibility (EMC).
PN-EN 61010-1:2011	Safety requirements for electrical equipment for measurement, control, and laboratory use. General requirements.
PN-EN 61243-5:2004	Live working. Voltage detectors. Voltage detecting systems (VDS).
PN-EN 60529:2003	Specification for degrees of protection provided by enclosures (IP code).

5. Technical parameters

5.1. Input/output circuits

Voltage input circuits

Number of inputs	3
Minimal voltage threshold, LCD signaling	3.4 V rms \pm 0.1 mV
Minimal voltage threshold, LED, relay signaling	3.4 V rms \pm 0.1 mV
Voltage hysteresis of the LED signaling	0.1 V rms
Input capacity	1500 pF + matching capacitor
Maximum length of the connected cables	< 3 m

Binary outputs

Switching capability at resistance load	2
	250 V AC, 5 A
	30 V DC, 5 A
	250V DC, 0.1 A
	1250 VA
Contacts material	AgNi
Maximum length of the connected cables	< 3 m

5.2. Power supply

Nominal voltage	☐ 24 V -20% +10%
Power consumption	< 1 W
Resistance to voltage dump	10 ms

5.3. Environmental conditions

Operational temperature	-25°C ... +55°C	
Storage temperature	-35°C ... +85°C	
Air humidity	lack of condensation and frost deposition	
Equipment class	0	
Overtoltage category	III	
Electrical environment	B	
Pollution degree	2	
Mechanical tests		
Sinusoidal vibration	class 1	
Single and multiple shocks and bumps	class 1	
Seismic	class 0	
Installation	indoor	

5.4. Construction

Mass	< 0,2 kg
Dimensions (width, height, depth)	125.5 / 55,7 / 50 mm

Degree of protection	
Front panel side	IP 54
Connector side with connectors plugged	IP 30

Connector

Type	Wago 254-454 Wago 734-138
	not exposed to corrosion

Connection wires	Stranded cable 0,5...2 mm ² (end sleeve) Solid cable 0,5...2.5 mm ²
Stripping length	10 .. 12 mm

Housing

mounting	flush-mounted
----------	---------------

5.5. Fuse

Internal fuse	FRN01WK0100A10
Required external protections of inputs, outputs and power supply	Select these according to general rules so that operation at exceeded rated levels at individual paths is not possible.

6. Description of connectors

Tab. 6.1. Connector X1

Terminal No	Designation	Description/ Purpose
1	L1	phase L1
2	L2	phase L2
3	L3	phase L3
4	PE	common for L1, L2, L3 (Earth PE)

Tab. 6.2. Connector X2

Terminal No.	Designation	Description / Purpose
1	DC/DC	Power supply 24 VDC (plus)
2		Power supply 24 VDC (minus)
3	DO_1	Output 1 - lack of voltage - normally closed contact
4		Output 1 - lack of voltage - normally opened contact
5		Output 1
6	DO_2	Output 2 - presence of voltage - normally closed contact
7		Output 2 - presence of voltage - normally opened contact
8		Output 2

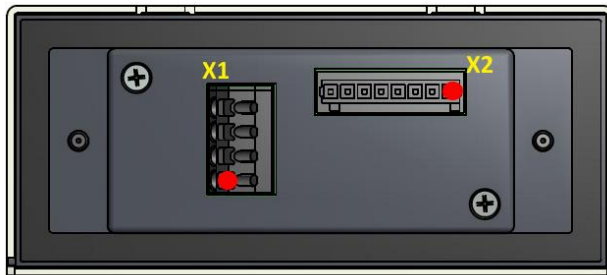

Rys. 6.1. Widok urządzenia od strony złącz



The red dot on the connector denotes the first pin of the terminal..

7. Connection diagram

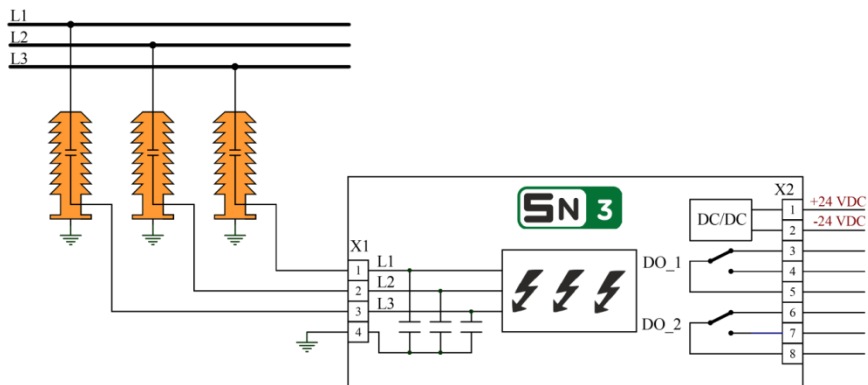

Fig. 7.1. Connection diagram

8. Dimension

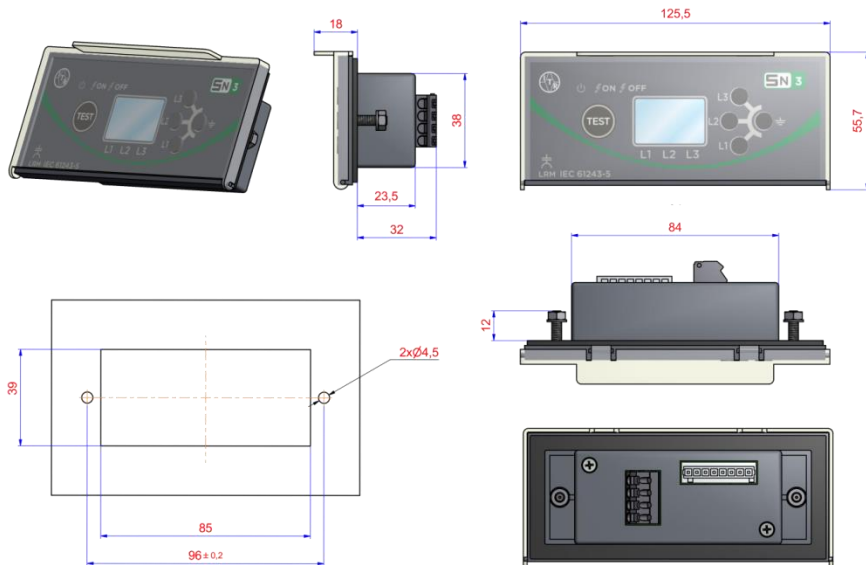

Fig. 8.1. Dimensions

9. Remarks of manufacturer

9.1. Maintenance, inspections, repairs



The manufacturer recommends that correctness of device operation is verified:

- a) each time - during commissioning,
- b) at least once a year - in mine face installations,
- c) at least once every 5 years in installations other than front face.

Also inspections resulting from branch regulations should be undertaken

9.2. Storage and transport



Devices are packed in transport packages and secured against damage during transport and storage. Devices should be stored in transport packages, indoors, in places free from vibrations and direct effects of weather conditions, dry, well ventilated, free from harmful vapors and gases. Ambient air temperature should be between -35°C and $+85^{\circ}\text{C}$, and relative humidity should not exceed 80%. All shipped devices are attached with user manual and warranty card.

9.3. Place of installation



SN 3 device is designed to installation in the mounting hole with dimensions of 85 mm x 35 mm at the door of the indoor power distribution bay. Length of single cable connected to device sockets cannot exceed 3 m.

Installation of the device:

- insert the device into the mounting hole
- tighten the set screws to the surface of the door

9.4. Disposal



Devices are made mostly from recyclable materials, or materials that can be processed again or disposed of in environmentally sound manner. Decommissioned devices can be collected for recycling, provided that their condition is that of normal wear and tear. All components that are not recyclable shall be disposed of in environmentally sound manner

9.5. Warranty and service



Regular 36-month guarantee period. Had the sale been preceded by execution of an Agreement between the Buyer and the Seller, provisions of such Agreement shall apply. Guarantee covers remedying of defects, free of charge, provided that instructions specified in the Warranty Card are adhered to. Detailed guarantee conditions may be found at energetyka.itr.org.pl in the „Sale Regulations”.

- The guarantee period is counted from the date of sale.
- The warranty is extended by a period of residence of the product in the repair.
- Unauthorized tampering with the product will void the warranty.
Warranty does not cover damage resulting from improper use of the product

10. Order specification

SN 3	A
Matching capacitor	
lack	0
47 nF	1
100 nF	2
150 nF	3
4,7 nF	4
10 nF	5
22 nF	6
15 nF	7
6,8 nF	8

Order example:

- SN3: A1 - matching capacitor 47 nF
- SN3: A2 - matching capacitor 100 nF



In device of specification higher than A0 on the lines L1, L2, and L3 additional protective spark gaps SAL-90 are installed. At the customer's request they can be not installed.



Other versions after consultation with the manufacturer.

11. Contact



Tele- and Radio Research Institute

ICT and Electronics Centre

03-450 Warsaw, ul. Ratuszowa 11

Poland

tel./fax: +48 22 590 73 91

e-mail: energetyka@itr.org.pl

www: energetyka.itr.org.pl